

SKSSV3001S

SINGLE WALL OVEN WITH STEAM-COMBI

SIGNATURE
KITCHEN SUITE



TRUE CONVECTION COOKING

The convection cooking system utilizes a third element and fan to cook food quickly and evenly, on every rack.

STEAM-COMBI CONVECTION OVEN

Versatile oven combines steam and convection cooking for gourmet results. The convection system cooks food quickly and evenly while steam helps to preserve texture, appearance and taste.

STEAM SOUS VIDE COOKING MODE

Enjoy sous vide results right in the spacious oven, without preheating. Achieve delicious results that are moist and tender on the inside, crisp and flaky on the outside, all with minimal effort.

SPEED-CLEAN™

Makes fast work of cleaning a lightly-soiled oven with just a ten minute cycle, using only water.

GLIDESHUT™ DOOR

The door opens and closes gently with grace and elegance.

WI-FI ENABLED FOR SMART CONTROL

The innovative wi-fi feature, powered by ThinQ® Technology, lets you cook and monitor from anywhere.

Innovation

Wi-Fi-Enabled for ThinQ® Control with iPhone / Android App	Yes
Remote Operations	Yes

Oven Features & Performance

Oven Type	Steam-Combi Convection
Capacity	4.7 cu. ft.
Cooking Modes	Convection Bake, Convection Roast, Bake, Broil, Gourmet Chef, Steam Cook (Steam-Combi, Gourmet Steam, Steam Sous Vide), Warm, Proof, My Recipes, RapidHeat Roast+
Interior Color	Blue
Oven Cleaning	Self Cleaning & Speed-Clean™
Variable Cleaning Time	Self Cleaning (3,4,5 hrs), Speed-Clean™ (10 min.)
Variable Broil	Yes (Full,Center / High,Med,Low)
Broil Element	2,500 W / 1,500 W
Bake Element	2,500 W
Steam Element	1,960 W
GlideShut™ Door	Yes
Oven Racks	2 Gliding, 1 Heavy Duty
Rack Positions	5
Oven Meat Probe	Yes
Automatic Shut Off (After 12 hrs.)	Yes
Star-K Certified Sabbath Mode	Yes
Interior Oven Lights (Auto & Manual)	2 Halogen
Convection System	True Convection
Convection Conversion	Yes
Convection Element	2,000 W
Proof	Yes
Variable Warm	Yes (High: 200°F, Med: 170°F, Low: 140°F)

© 2020 Signature Kitchen Suite. All rights reserved. Design, features and specifications are subject to change without notice. Specifications are for planning purposes only. Consult the product's installation instructions for final dimensional data and other details prior to making cutouts or custom panels. Consult with a heating and ventilation engineer for your specific ventilation requirements. Non-metric weights and measurements are approximate. Smart features require Internet access.

1-855-790-6655 | www.signaturekitchensuite.com

SKSSV3001S

SINGLE WALL OVEN WITH STEAM-COMBI

SIGNATURE
KITCHEN SUITE

Controls

Oven	Knob+LCD Touch Screen
Display	7 inch LCD
Electronic Clock & Timer	Yes
Lock Out Function	Yes
Delay Start Time	Yes
Preheat Alarm Light	Yes
Audible Preheat Signal	Yes
Cooking Complete Reminder	Yes
Temperature Display (F or C)	Yes
Language Options	English, Spanish, French

Technical Specs

Rating (240V / 208V)	6.1 kW / 4.6 kW
Required Power Supply	240 / 208V, 30 Amp

Dimensions and Weight

Overall Width (inches)	29 3/4
Overall Depth Including Door (inches)	24 1/2
Overall Depth Including Handle (inches)	27
Overall Depth with Door Open (inches)	45 5/8
Overall Height (inches)	29 7/16
Size of Water Tank	1 Liter
Net Weight (approx.)	140 lbs
Shipping Weight (approx.)	187 lbs

Accessories

Included Accessories

Broiler Pan, Grid, 2 Gliding Racks, Heavy Duty Rack, Meat Probe, Cleaning Pad, Spray Bottle

Warranty Summary*

Limited Warranty, Parts & Labor	3 Years
---------------------------------	---------

*These warranties give you specific legal rights and you may have other rights that vary from state to state. For complete warranty details, refer to your Use & Care manual.

SKSSV3001S

SINGLE WALL OVEN WITH STEAM-COMBI

PRODUCT DIMENSIONS

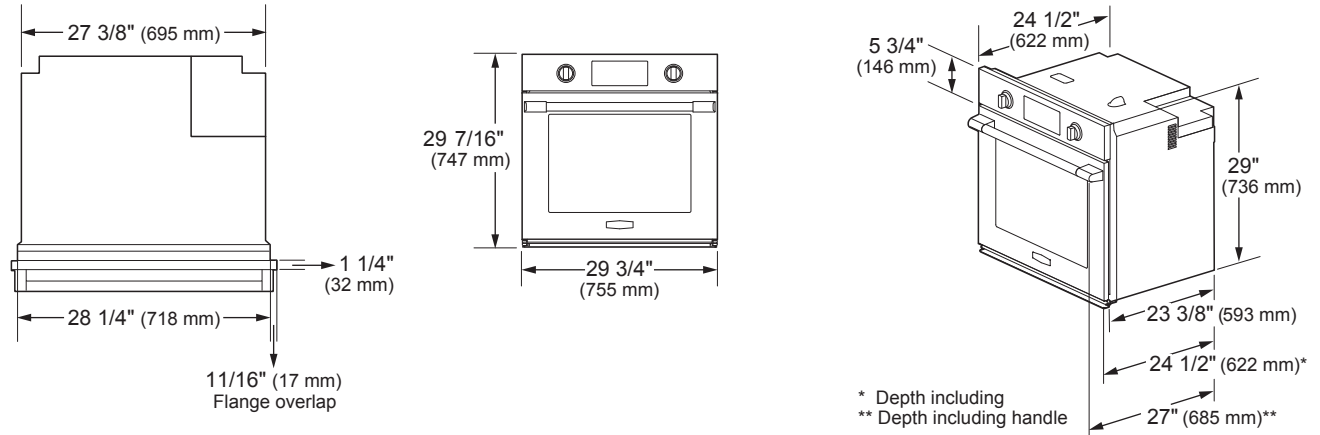

CUTOUT DIMENSIONS – PROUD INSTALLATION IN WALL CABINET

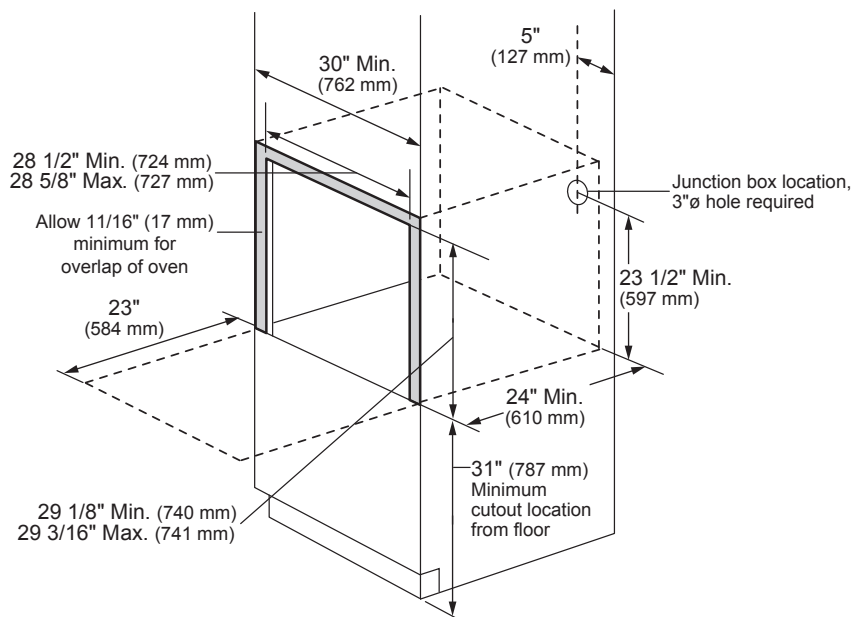

Refer to the Wall Oven Planning Installation Guide for flush installation, undercounter installation and single oven with microwave and trim kit installed in wall cabinet.